

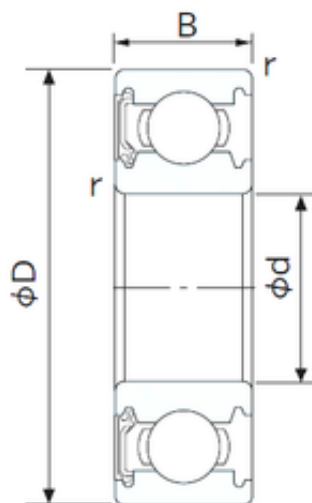

PRECISÃO AXLE CORP



17 mm x 30 mm x 7 mm NACHI 6903NSE Rolamentos de esferas profundas

Bearing No. 6903NSE

Size	17x30x7 mm
Bore Diameter	17 mm
Outer Diameter	30 mm
Width	7 mm
d	17 mm
D	30 mm
B	7 mm
C	7 mm
r min.	0.3 mm
da min.	19 mm
Da max.	28 mm
ra max.	0.3 mm
Weight	0.018 Kg
Basic dynamic load rating (C)	4,6 kN
Basic static load rating (C0)	2,55 kN
(Grease) Lubrication Speed	14000 r/min

6903NSE Bearing 2D drawings and 3D CAD models